

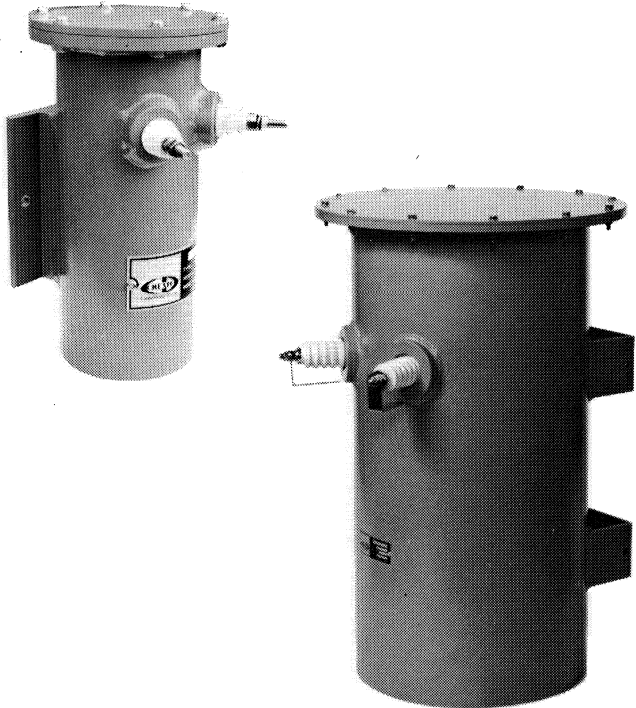

HF Transmitter-to-Antenna Interface Balun Transformer

- ★ Broadband
- ★ Low Insertion Loss
- ★ Rugged Construction



Offering a wide range of transformation ratios in the 2 to 30MHz frequency range. Couples 50,75 ohm unbalanced coaxial transmitter output to a 50,75,300 or 600 ohm balanced input, open-wire transmission line or, conversely, couples a 300 or 600 ohm line to a 50 or 75 ohm unbalanced antenna input. Equipped with panel receptacle type coaxial input connector on all baluns and the balanced outputs are through ceramic feed-through bushings. Transmitting baluns are supplied with spark gaps for lightning protection.

SPECIFICATIONS

Specifications Common to All CD Baluns

Frequency Range	2 ~ 30 MHz
Insertion VSWR Less Than	1.2 : 1
Voltage Balance	Less Than 5 %
Insertion Loss	Less Than 0.3 dB
Ambient Temperature Range	-40 °C to +50 °C
Relative Humidity	up to 95 %
Lightning Protection	External Spark Gaps

Model	Z-in/Z-out ohms	Power Capability Average/PEP	Max. Load VSWR	Connector Female	Case Outline	Weight
CB4K/50	50/50	1/ 2kW	3:1	N	CB4K	1.7kg
CB4K/200	50/200	1/ 2kW	3:1	N or LC	CB4K	2kg
CB4K/300	50/300	1/ 2kW	3:1	N or LC	CB4K	2kg
CB4K/600	50/600	1/ 2kW	3:1	N or LC	CB4K	2kg
CB10KB/50	50/50	10/20kW	3:1	7/8"EIA	CB10KB	9.5kg
CB10K/200	50/200	5/10kW	3:1	7/8"EIA	CB10K	10kg
CB10K/300	50/300	5/10kW	3:1	7/8"EIA	CB10K	10kg
CB10K/600	50/600	5/10kW	3:1	7/8"EIA	CB10K	10kg
CB20KA/200	50/200	10/20kW	2.5:1	1-5/8"EIA	CB20KA	12kg
CB20KA/300	50/300	10/20kW	2.5:1	1-5/8"EIA	CB20KA	12kg
CB20KA/600	50/600	10/20kW	2.5:1	1-5/8"EIA	CB20KA	12kg
CB30K/200	50/200	10/30kW	3:1	1-5/8"EIA	CB30K	36kg
CB30K/300	50/300	10/30kW	3:1	1-5/8"EIA	CB30K	36kg
CB30K/600	50/600	10/30kW	3:1	1-5/8"EIA	CB30K	36kg

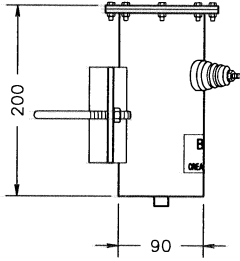
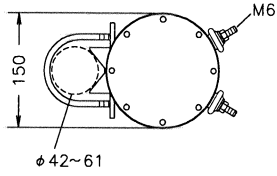

CB4K/xx

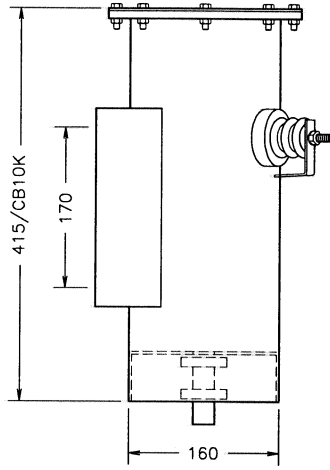
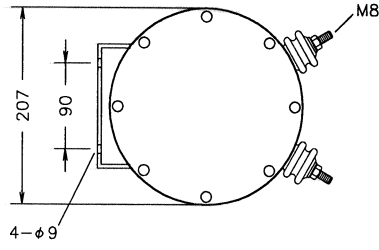

CB10K/xx

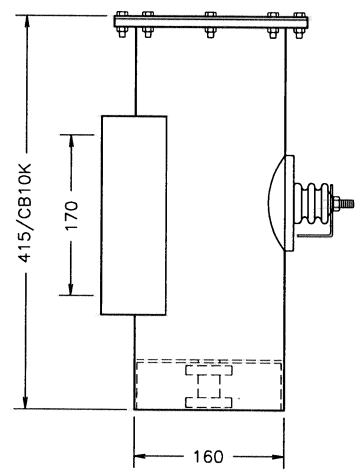
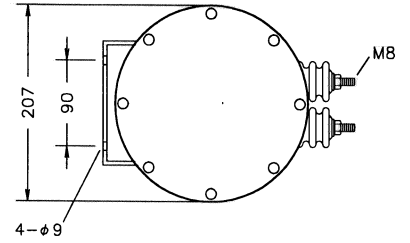

CB10KB/xx

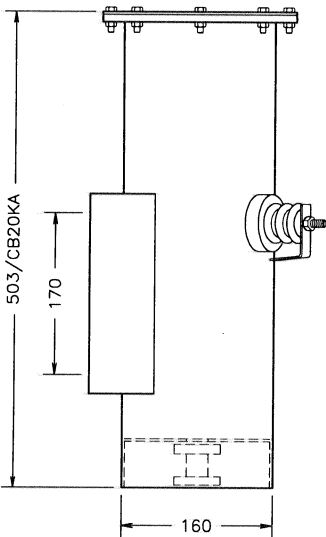
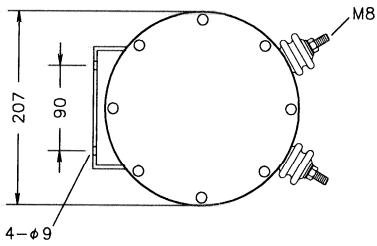

CB20K/xx

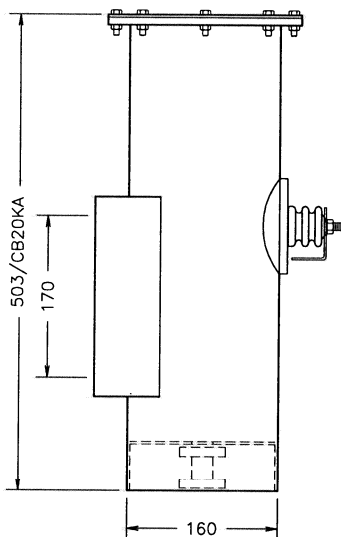
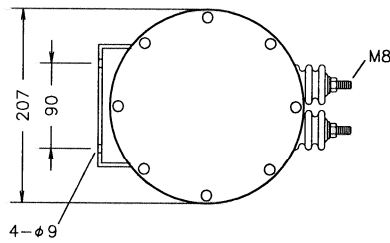

CB20K/xx

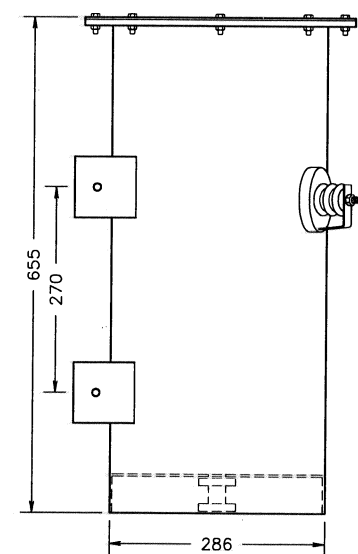
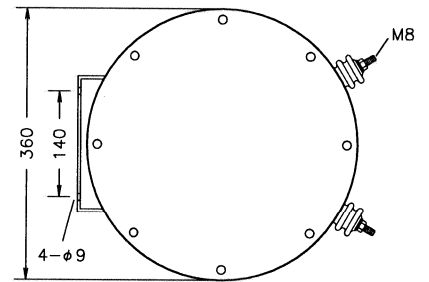

CB30K/xx

BROADBAND HF BALUN TRANSFORMER



CB-3F/x

- ☆ Broadband
- ☆ Receiving and Transmitting

Offering a wide range of transformation ratios in the 2 to 30 MHz frequency range, the CB-3F series utilize ferrite cores to reduce distortion and intermodulation. The 70 watt baluns are packaged in plastic cases. The coaxial input connector on all baluns are UG-58A/U (N) type panel receptacle. Transmitting baluns are supplied with spark gaps for protection. The DC. resistance from the coaxial center conductor to ground is less than 0.1 ohms. The ratio of unbalanced voltage to balanced voltage are less than 5 percent to all baluns.

SPECIFICATIONS

MODEL	U-IN/B-OUT (ohms)	POWER Ave./PEP.	INSERTION Loss dB	INSERTION VSWR
CB3F/101	50/50	70/140W	Less Than 0.3 db	Less Than 1.2:1
CB3F/111	50/110			
CB3F/201	50/200			
CB3F/301	50/300			
CB3F/401	50/600			

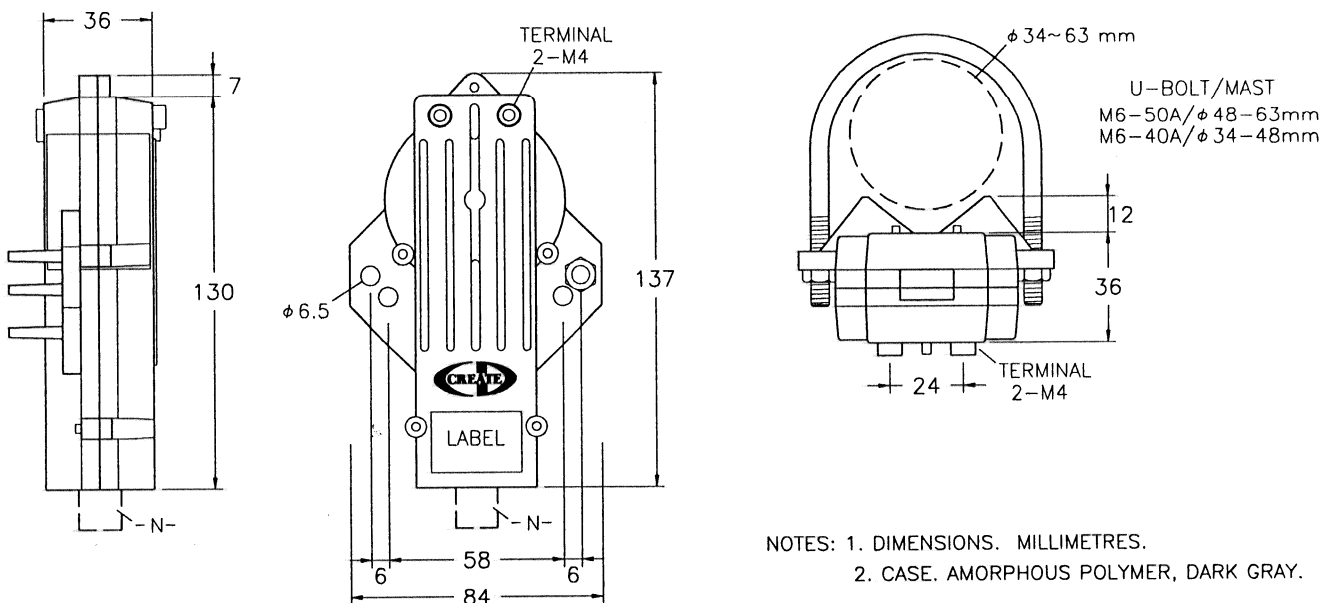

CB-3F/x, Balun Transformer.

DWGA.072B

IMPEDANCE TRANSFORMERS

CA-75xx Series

★ HF Band, 50/75 Ohms



This impedance transformer model CA-75xx is a 50 ohm : 75 ohms, unbalanced type transformer. In the standard model, there are three types of models of impedance transformers either 1kW, 5kW and 15kW are available. This CA-75xx provides a low VSWR characteristics with a low loss power energy over wide range of frequency bands. This Transformers has a no restriction on the installation site (a water proof) and installation directivity either.

SPECIFICATIONS

	CA7501	CA7505-F	CA7515-F
Frequency Range	2~30 MHz	2~30 MHz	2~30 MHz
Impedance Ratio	50:75 ohms	50:75 ohms	50:75 ohms
Power Capability (Ave./PEP)	1/2 kW	5/10 kW	15/25 kW
Insertion Loss MAX.	0.1 dB	0.1 dB	0.1 dB
Insertion VSWR MAX.	1.2:1	1.2:1	1.2:1
Connector	NJ	7/8" EIA	1-5/8" EIA
Weight Approx.	0.4 kg	1.6 kg	2.0 kg

Note: The type of connector is substitutable upon request.

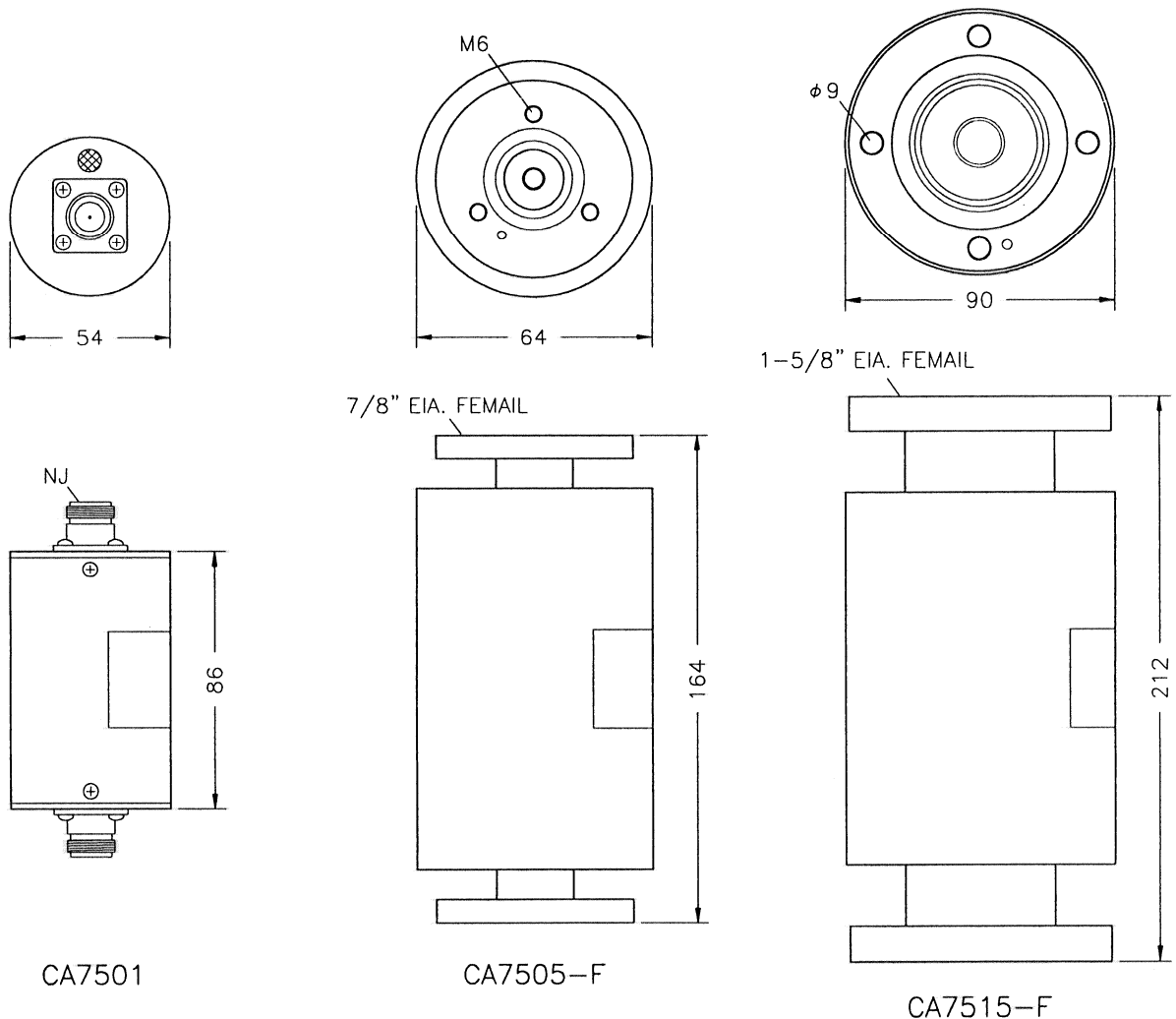

CA-75xx, Outline Dimensions.

DWGE.148